

深圳市晶科鑫实业有限公司

样品承认书

| | |
|-----------|---|
| 客户代码: | |
| 物料名称: | 贴片钟振 |
| 规格型号: | SMD3225 OSC 19.200MHZ 1.8~3.3V LV CMOS -20~70℃ |
| P N/ SJK: | 3N19200G33YB |
| 环保属性: | <input checked="" type="checkbox"/> RoHS <input checked="" type="checkbox"/> REACH <input checked="" type="checkbox"/> HF <input type="checkbox"/> PAHS <input type="checkbox"/> 其它 |
| 版 次: | A1 2017-5-10 初版 |
| 湿敏等级: | 一级 |

| 承 认 签 章 | | | | | |
|-----------|--|-----|-------------|-----|-----|
| 供 应 商 承 认 | | | () 公 司 承 认 | | |
| 制 定 | 审 核 | 核 准 | 工 程 师 | 审 核 | 批 准 |
| 贺丹斌 | | 黄灏东 | | | |
| SJK 支持 | 18682088994 (Mr.黄) | | 盖章签署 | | |
| FAE_EMAIL | sjk-fae@q-crystal.com | | 日 期 | | |
| 日 期 | | | | | |
| 备注: | | | | | |



CRYSTAL OSCILLATOR

SERIES 3N, SEAM SEALED CERAMIC 3.2X2.5MM SURFACE MOUNT PACKAGE

1. ELECTRICAL SPECIFICATIONS

Standard atmospheric conditions

Unless otherwise specified, the standard range of atmospheric conditions for making measurement and tests are as follow:

Ambient temperature : 25±5°C

Relative humidity : 40%~70%

If there is any doubt about the results, measurement shall be made within the following limits:

Ambient temperature : 25±3°C

Relative humidity : 40%~70%

Measure equipment

Electrical characteristics measured by MD 37WX-05M or equivalent.

Crystal cutting type

The crystal is using AT CUT (thickness shear mode).

| | Parameters | | SYM | Electrical Spec. | | | | Notes |
|----|---------------------------|----------------------------------|-------|------------------|------|---------|---------|-------------------|
| | | | | MIN | TYPE | MAX | UNITS | |
| 1 | Nominal Frequency | | | 19.200000 | | | MHZ | |
| 2 | Frequency Stability | AT 25°C | | ±10 | | | PPM | |
| | | Over Operating Temperature range | | ±10 | | | PPM | -20~70°C |
| | | | | ±20 | | | PPM | -40~85°C |
| 3 | Operating Temperature | | Topr | -20 | 25 | 70 | °C | |
| 4 | Storage Temperature | | Tstg | -55 | ~ | 125 | °C | |
| 5 | Supply Voltage | | VDD | 1.62~3.63 | | | V | |
| 6 | Input Current | | Icc | | | 5 | mA | |
| 7 | Enable Control | | | Yes | | | | Pad1 |
| 8 | Output Load : CMOS | | CL | 15 | | | pF | |
| 9 | Output Voltage High | | VoH | 90% Vdd | | | V | |
| 10 | Output Voltage Low | | VoL | | | 10% Vdd | V | |
| 11 | Rise Time | | Tr | | | 5 | ns | 10%→ 90%VDD Level |
| 12 | Fall Time | | Tf | | | 5 | ns | 90%→ 10%VDD Level |
| 13 | Symmetry (Duty ratio) | | TH/T | 45 | ~ | 55 | % | |
| 14 | Start-up Time | | Tosc | | | 10 | ms | |
| 15 | Enable Voltage High | | Vhi | 70% Vdd | | | V | |
| 16 | Disable Voltage Low | | Vlo | | | 30% Vdd | V | |
| 17 | Aging | | | ±3 | | | ppm/yr. | 1st. Year at 25°C |
| 18 | Output Disable Delay Time | | T off | | | 150 | us | |
| 19 | Output Enable Delay Time | | T on | | | 150 | us | |

电话: 0755-88352810-837(Mr.huang) 传真: 0755-88353718 <http://www.q-crystal.com>

公司地址: 深圳市龙岗区天安云谷产业园一期 3 栋 C 座 12 楼 1204~1206 室

CRYSTAL OSCILLATOR

SERIES 3N, SEAM SEALED CERAMIC 3.2X2.5MM SURFACE MOUNT PACKAGE

| | | | | | | |
|----|----------------------------|--|-----|-----|----|--|
| 20 | Phase Jitter (12KHZ~20MHZ) | | 0.5 | 1.0 | ps | |
|----|----------------------------|--|-----|-----|----|--|

2. DIMENSIONS (Units :mm)

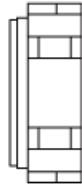
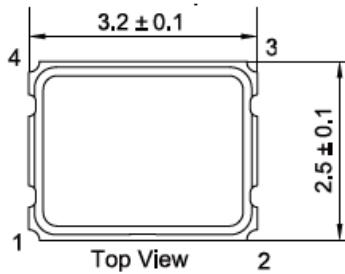

PAD FUNCTION:

- 1: ENABLE CONTROL
- 2: GND
- 3: OUT
- 4: VDD

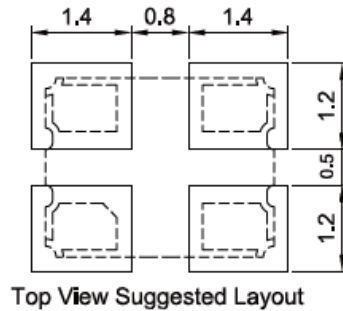
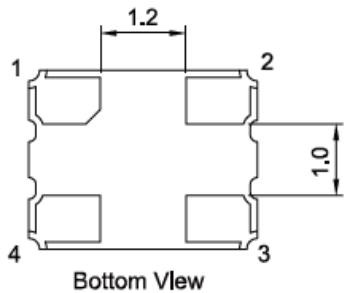
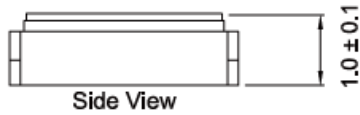

3. MARKING

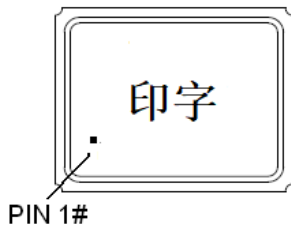

4. TEST CIRCUIT

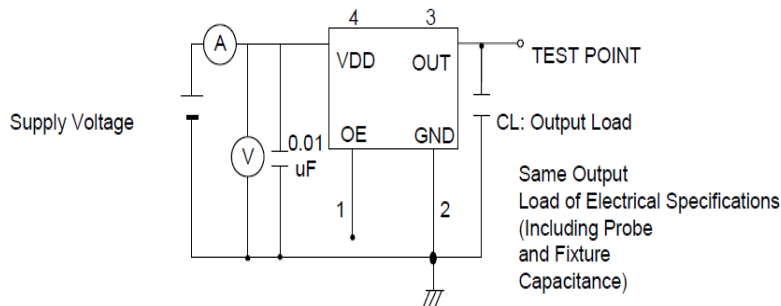

Control input (output enable/disable)
 Logic 1 or open on pad 1:
 Oscillator output
 Logic 0 on pad 1 : Disable output to high impedance

CRYSTAL OSCILLATOR

SERIES 3N, SEAM SEALED CERAMIC 3.2X2.5MM SURFACE MOUNT PACKAGE

5. WAVEFORM CONDITIONS

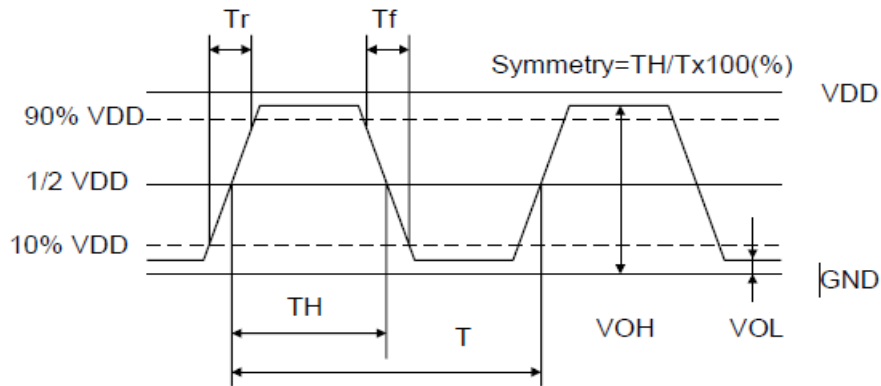

Waveform measurement system should have a min. bandwidth of 5 times the frequency being tested.

6. OUTPUT ENABLE / DISABLE DELAY

The following figure shows the oscillator timing during normal operation. Note that when the device is in standby, the oscillator stops. When standby is released, the oscillator starts and stable oscillator output occurs after a short delay

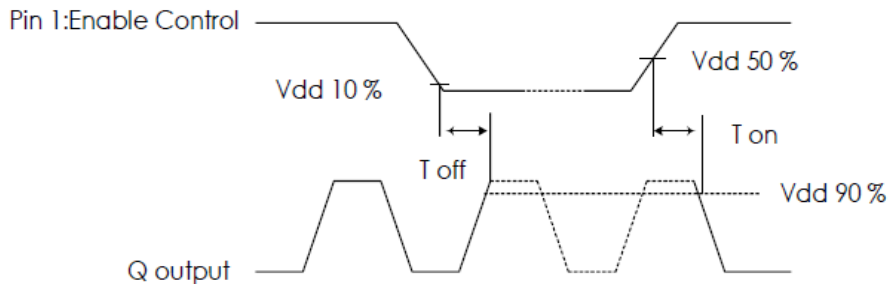

7. SUGGESTED REFLOW PROFILE

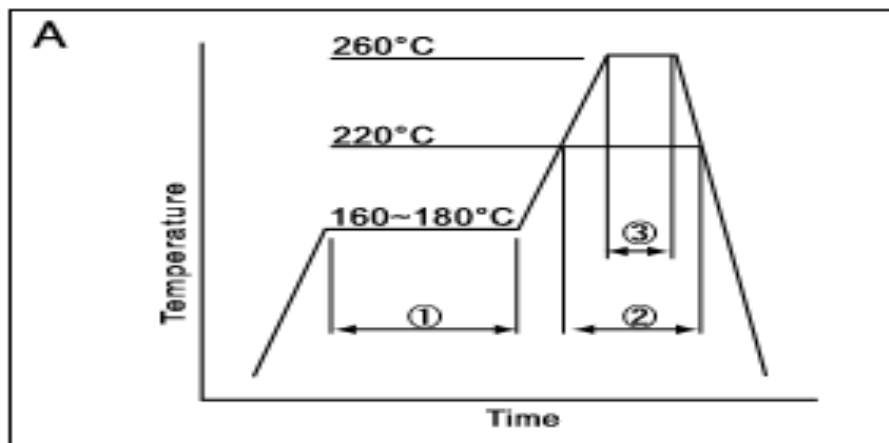

| | | | |
|---|--------------|-----------|------------|
| ① | Preheat | 160~180°C | 120sec. |
| ② | Primary heat | 220°C | 60sec. |
| ③ | Peak | 260°C | 10sec. max |

CRYSTAL OSCILLATOR

SERIES 3N, SEAM SEALED CERAMIC 3.2X2.5MM SURFACE MOUNT PACKAGE

Total time : 200 sec. Max / Solder melting point :220 °C

8. RELIABILITY TEST SPECIFICATION

1.Mechanical Endurance

| No. | Test Item | Test Methods | REF. DOC |
|-----|------------------|---|--------------|
| 1 | Drop Test | 75 cm height,3 times on concrete floor . | JIS C6701 |
| 2 | Mechanical Shock | Device are shocked to half sine wave (1000 G) three mutually perpendicular axes each 3 times. 0.5m sec. duration time | MIL-STD-202F |
| 3 | Vibration | Frequency range 10 ~ 2000 Hz Amplitude 1.52 mm/20G Sweep time 20 minutes Perpendicular axes each test time 4 Hrs (Total test time 12 Hrs) | MIL-STD-883E |
| 4 | Gross Leak | Standard Sample For Automatic Gross Leak Detector, Test Pressure: 2kg / cm ² | MIL-STD-883E |
| 5 | Fine Leak | Helium Bomging 4.5 kgf / cm ² for 2 Hrs | |
| 6 | Solderability | Temperature 245 °C ± 5°C Immersing depth 0.5 mm minimum Immersion time 5 ± 1 seconds Flux Rosin resin methyl alcohol solvent (1 : 4) | MIL-STD-883E |

2.Environmental Endurance

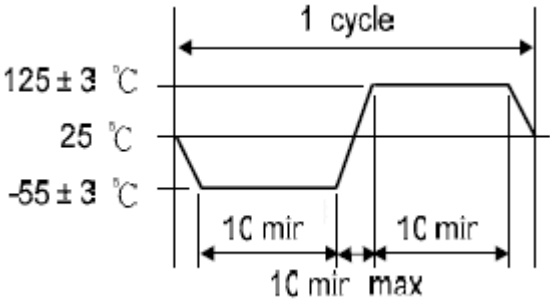
| No. | Test Item | Test Methods | REF. DOC |
|-----|------------------------------|---|--------------|
| 1 | Resistance To Soldering Heat | Pre-heat temperature 125 °C ; Pre-heat time 60 ~ 120 sec. Test temperature 260 ± 5 °C ; Test time 10 ± 1 sec. | MIL-STD-202F |
| 2 | High Temp. Storage | + 125 °C ± 3 °C for 1000 ± 12 Hrs | MIL-STD-883E |
| 3 | Low Temp. Storage | - 40 °C ± 3 °C for 1000 ± 12 Hrs | |
| 4 | Thermal Shock | Total 100 cycles of the following temperature cycle  | MIL-STD-883E |
| 5 | Pressure Cooker Storage | 121 ± 3°C , RH100% , 2 bar , 240 Hrs | JIS C6701 |
| 6 | High Temp & Humidity | 85°C ± 3°C, RH 85% , 1000 Hrs | JIS C5023 |

备注

电话: 0755-88352810-837(Mr.huang) 传真: 0755-88353718 <http://www.q-crystal.com>

公司地址: 深圳市龙岗区天安云谷产业园一期3栋C座12楼1204~1206室

CRYSTAL OSCILLATOR



SERIES 3N, SEAM SEALED CERAMIC 3.2X2.5MM SURFACE MOUNT PACKAGE
